

DATA-FUSION FOR ROTATION MEASUREMENT IN THREE DEGREES OF FREEDOM

David Skula

Doctoral Degree Programme (1), FEEC VUT
E-mail: xskula00@stud.feec.vutbr.cz

Supervised by: Luděk Žalud
E-mail: zalud@feec.vutbr.cz

ABSTRACT

This article deals with creating a module that can measure the angle of rotation in three mutually perpendicular axes. For this purpose, it is possible to use the sensors of angular velocity, linear acceleration and magnetic field. Each of these sensors has advantages and disadvantages. The purpose of data fusion from all sensors is to suppress these disadvantages and combine the advantages to achieve greater accuracy than the sensors themselves.

1. INTRODUCTION

Sensor of angular velocity is called gyroscope, sensor of linear acceleration is accelerometer and sensor of magnetic field is magnetometer. Recently are popular sensors based on MEMS technology, which allows to create mechanical parts of sensors (referential mass of gyroscope and accelerometer) on silicon chip with dimensions of the order of millimeters. The accuracy of these sensors is not as good as regular sensors. Therefore, it offers the possibility of combination more sensors for data fusion in order to improve accuracy.

2. ANALYSIS

2.1. GYROSCOPE

Output of the gyroscope is proportional to angular velocity. Information about the angle of rotation from the beginning of integration is obtained by integration. It is a relative measurement. The main advantage of gyroscope is a small dependence on acceleration. It is possible to use a gyroscope to measure rotation around the axis with random orientation against the earth's surface. The disadvantage is a significant dependence on temperature and the error caused by integrating the output signal.

Chosen sensor was Analog Devices - ADIS16350 [2]. This is the three-axis gyroscope and accelerometer in a single package, output is via digital interface SPI.

The Fig.1 shows gyroscope output in dependence on the temperature at zero angular velocity. The dependence is linear. From the measured data is calculated correction equation (1).

$$\omega_k = \omega + \frac{0,1155}{f_{vz}} \cdot (T - 25) \quad (1)$$

Where ω is the measured angular velocity, f_{vz} is the sampling rate and T is the temperature.

If we suppress negative temperature impact and angular velocity is zero we are getting non-zero gyro output - so-called offset. We also have to count with output noise. Integral error is caused by offset. Significant suppression is achieved by measuring the offset at stable temperature conditions and zero angular velocity. Offset is then deducted from the measured values. With Allan Variance method [3] (analysis of the sequence of samples over time, intended to remove the effects of noise on the average value sequence) was the most appropriate time for measuring the offset set at 300s.

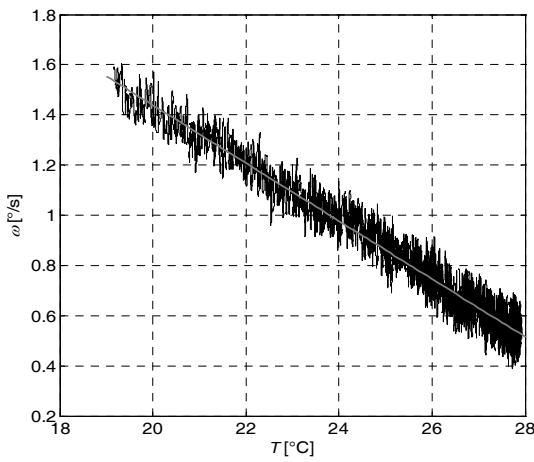

Fig.1: Temperature impact on gyroscope

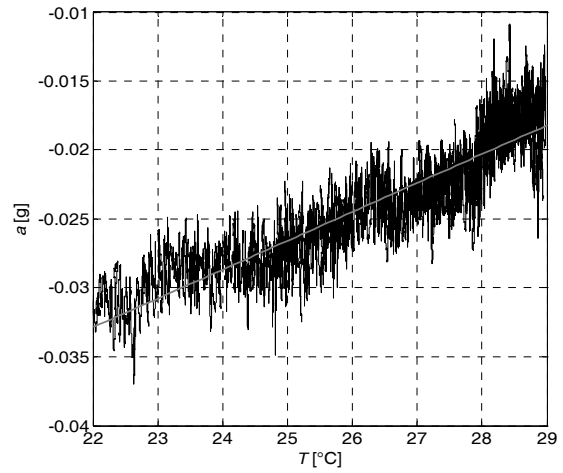

Fig.2: Temperature impact on accelerometer

2.2. ACCELEROMETER

It is used to measure tilt towards the horizontal axis (as an inclinometer). The horizontal axis corresponds to zero measured acceleration, vertical position corresponds to the measured value of 1g. The advantage is the absolute way to measure tilt (due to the gravity vector). The disadvantage is sensitivity to the other acceleration due to shake or movement and a dependence on temperature.

The module uses three-axis accelerometer from the mentioned ADIS16350 sensor. Accelerometers are used to measure the angle along horizontal axis with the Earth's surface.

Because the availability of information about the acceleration in the axis perpendicular to the Earth's surface, the measured acceleration is calculated to the tilt angle using (2). This ensures a good sensitivity throughout the range of 0° to 90° (unlike a simple sine function).

$$a \tan 2(z, x) = \begin{cases} a \tan\left(\left|\frac{z}{x}\right|\right) \cdot \text{sgn}(z) & x > 0 \\ \frac{\pi}{2} \cdot \text{sgn}(z) & x = 0 \\ (\pi - a \tan\left(\left|\frac{z}{x}\right|\right)) \cdot \text{sgn}(z) & x < 0 \end{cases} \quad a \tan 2(0, x) = \begin{cases} 0 & x > 0 \\ \text{undef.} & x = 0 \\ \pi & x < 0 \end{cases} \quad (2)$$

Where z is the acceleration in perpendicular axis and x in the horizontal axis to the Earth's surface and $\text{sgn}()$ is the *signum* function.

The Fig.2 shows accelerometer output in dependence on the temperature at zero acceleration. The dependence is linear. From the measured data is calculated correction equation (3).

$$a_k = a - 0,0021 \cdot (T - 25) \quad (3)$$

Where a is the measured acceleration and T is the temperature.

2.3. MAGNETOMETER

It is used to measure the Earth magnetic field like compass. The main advantage is the absolute way to measure (due to the Earth magnetic field vector). The disadvantage is the temperature dependence (offset changes), sensitivity to foreign magnetic field, metal objects and the tilt influence.

In this project is used three-axis magnetometer HMC1043 [4] (Honeywell company). The output is an analogue. Each axis contains Wheatston bridge composed with magnetically sensitive resistors. Because range of output voltage is around 3mV, we used amplifier according Fig.3. Then here is an A/D converter AD776 (Analog Devices company) with SPI communication interface.

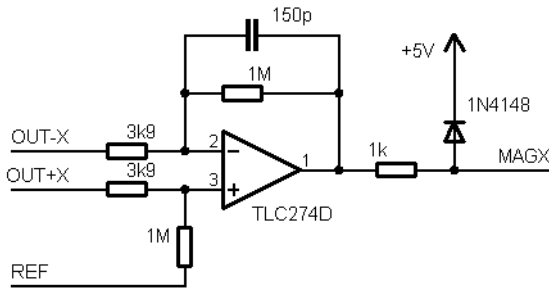

Fig.3: Amplifier for magnetometer

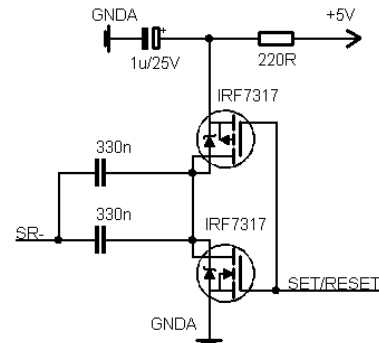

Fig.4: SET – RESET circuit

Outputs of magnetometer are three values proportional with magnetic field in three axes. Azimuth (angle of deflection from the north) is obtained from the horizontal magnetic field of the Earth's surface (4).

$$\alpha = a \tan \frac{H_{EY}}{H_{EX}} \quad (4)$$

The temperature effect is compensated by using a set-reset coils [5] (implemented in the sensor). Coils are operated in accordance with circuit Fig.4. In the SET mode is the magnetic field measured with a positive scale factor, in the RESET mode with negative scale factor. Average of both values is the offset of axis. This is subtracted from the measured data. Process is performed at each measurement and for each axis of magnetometer. In each step is obtained the current offsets of each axis and temperature effects is reduced. In Fig.5 is shown the measurement error depending on the tilt angle. Different curves represent different azimuth settings. Error is compensated by using

equation (5). With the knowing of tilt angles, the equation recalculate measured data into the horizontal planes (matrix of rotation [6]). Compensation result is shown in Fig.6.

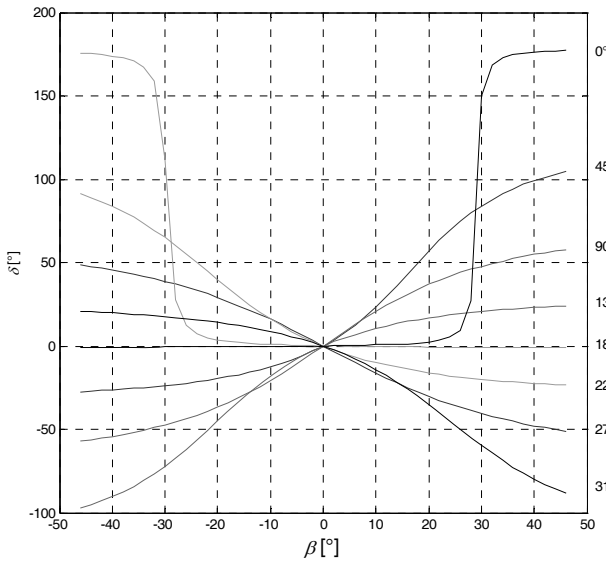

Fig.5: Measurement error

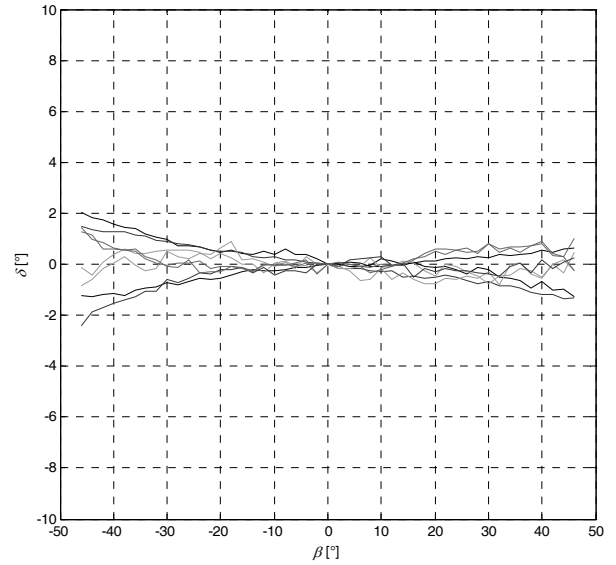

Fig.6: Compensation result

$$\begin{bmatrix} S_{x0} \\ S_{y0} \\ S_{z0} \end{bmatrix} = \begin{bmatrix} \cos \beta & 0 & \sin \beta \\ \sin \alpha \cdot \sin \beta & \cos \alpha & -\sin \alpha \cdot \cos \beta \\ -\cos \alpha \cdot \sin \beta & \sin \alpha & \cos \alpha \cdot \cos \beta \end{bmatrix} \times \begin{bmatrix} S_{x1} \\ S_{y1} \\ S_{z1} \end{bmatrix} \quad (5)$$

Where α, β are tilt angles along x, y axis and S_{x1}, S_{x2}, S_{x3} are the measured values of magnetic field.

2.4. HW OF THE MODULE

The block diagram whole device is in Fig.7. Microprocessor (ATMEGA8 from ATMEL company) collects data from all sensors. Microprocessor collects data from all sensors and sends it to the PC for processing over the RS-232. In Fig.8 is the photo of finished device.

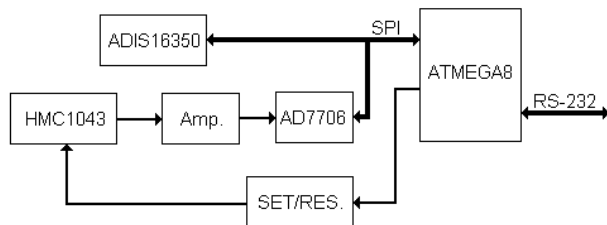

Fig.7: Block diagram of the device

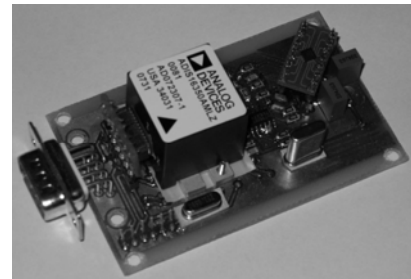

Fig.8: Picture of the device

2.5. DATA-FUSION

The basic is always a gyroscope. Integral error is suppressed less accurate absolute sensor (for the horizontal axis are accelerometers for the vertical axis is the magnetometer). Block

diagram of this process is in Fig.9. The difference between the angle of the gyroscope and the angle of the absolute sensor is multiplied by a constant k and subtracted from the angle of the gyroscope [7].

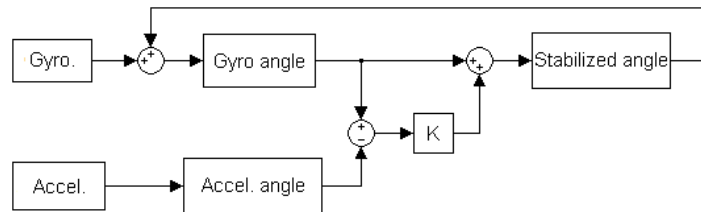

Fig.9: Block diagram of compensation process

3. CONCLUSION

The result of this work is functional prototype. Assuming the angle of tilt to 45° and azimuth in its entirety is the accuracy of measurement of about 2° . The noise of the final angle of rotation is much smaller than the noise of the sensors. Now is developing the next version that would use a more sophisticated method for data fusion in absolute and relative sensor: Kalman filter.

Acknowledgement:

This work has been supported in part by Ministry of Education, Youth and Sports of the Czech Republic (Research Intent MSM0021630529 Intelligent systems in automation), Grant Agency of the Czech Republic (102/09/H081 SYNERGY - Mobile Sensoric Systems and Network) and by Brno University of Technology. Without kind support of the above-mentioned agencies and institutions the presented research and development would not be possible.

REFERENCES

- [1] SKULA, David. *Data-Fusion for Rotation Measurement*. Diploma thesis in Czech, FEKT VUT Brno 2008
- [2] *Datasheet ADIS16350, Rev. A*. Analog Devices
- [3] STOCKWELL, Walter. *Bias Stability Measurement: Allan Variance*. Crossbow.
- [4] *Datasheet HMC1043, Rev. C*. Honeywell
- [5] *Set/Reset Function for Magnetic Sensor*. Honeywell
- [6] ŠOLC, František, ŽALUD, Luděk. *Robotika*. FEKT VUT. Brno 2002
- [7] *Measurement of a Vehicle's Dynamic Motion*. Crossbow